

Radio Astronomy 101

K. M Shariat Ullah

*Student, Department of Electrical and Electronic Engineering,
Shahjalal University of Science and Technology, Sylhet*

Day 4 : Amplifier and Filter

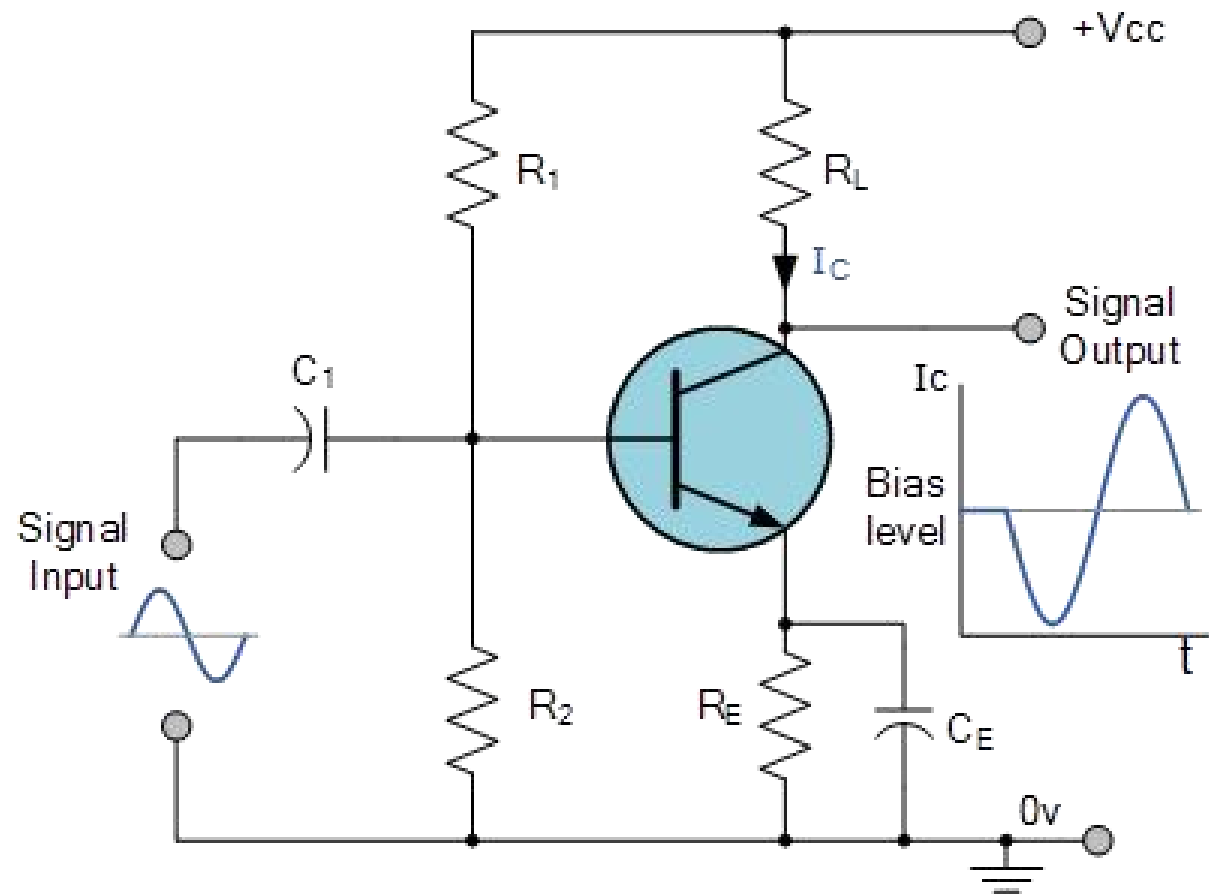

Amplifier

Original signal
(complex signal)

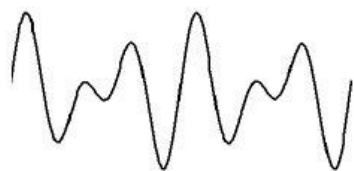

=

Component
Frequencies

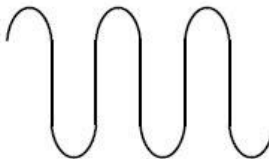

+

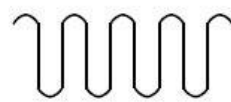

+

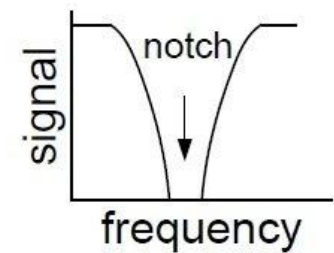
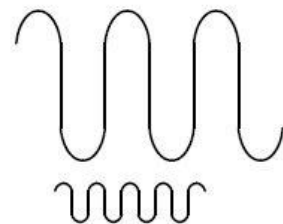
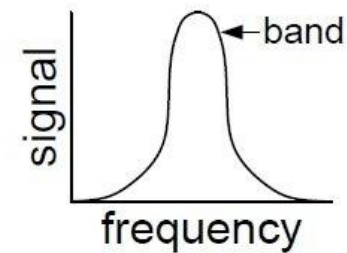
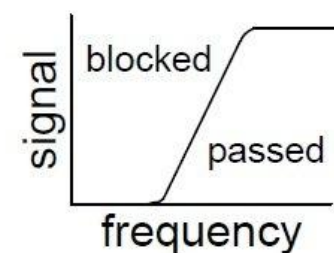
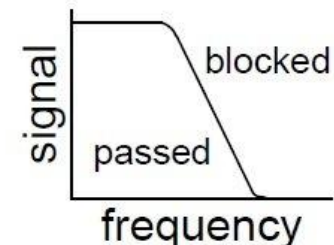
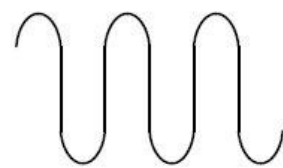

Any Questions?